

MACHEREY-NAGEL

User manual

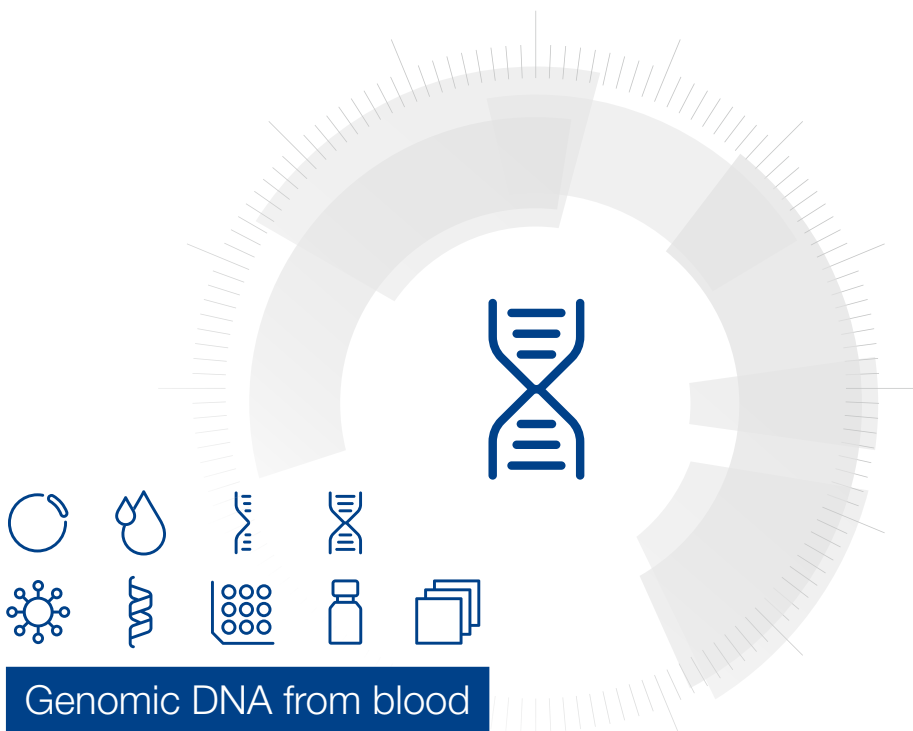

Genomic DNA from blood

- NucleoSpin® 96 Blood
- NucleoSpin® 96 Blood Core Kit

April 2019 / Rev. 10

Table of contents

1	Components	4
1.1	Kit contents	4
1.2	Reagent to be supplied by user	5
2	Product description	6
2.1	The basic principle	6
2.2	Kit specifications	6
2.3	Required hardware	7
2.4	Recommended accessories for use of the NucleoSpin® 96 Blood Core Kit	8
2.5	Automated processing on robotic platforms	9
2.6	Elution procedure	10
3	Storage conditions and preparation of working solutions	11
4	Safety instructions	12
5	Protocols	14
5.1	NucleoSpin® 96 Blood – vacuum processing	14
5.2	NucleoSpin® 96 Blood – centrifuge processing	20
5.3	Modified lysis of blood samples	20
5.4	Cultured animal or human cells	21
6	Appendix	22
6.1	Troubleshooting	22
6.2	Ordering information	24
6.3	Product use restriction / warranty	25

1 Components

1.1 Kit contents

NucleoSpin® 96 Blood			
REF	1 x 96 preps 740665.1	4 x 96 preps ¹ 740665.4	24 x 96 preps ¹ 740665.24
Lysis Buffer BQ1	45 mL	125 mL	6 x 125 mL
Wash Buffer B5 (Concentrate) ²	100 mL	2 x 100 mL	12 x 100 mL
Wash Buffer BW	100 mL	300 mL	6 x 300 mL
Elution Buffer BE ³	60 mL	125 mL	6 x 125 mL
Proteinase K (lyophilized) ²	75 mg	4 x 75 mg	24 x 75 mg
Proteinase Buffer PB	2 x 1.8 mL	15 mL	6 x 15 mL
NucleoSpin® Blood Binding Plates (red rings)	1	4	24
MN Wash Plates ⁴	1	4	24
Lysis Blocks	1	4	24
Rack of Tube Strips ⁵	1	4	24
Tubes (2 mL) for Proteinase K	4	16	96
Tubes (15 mL) for BioRobot® 9604	8	32	192
User manual	1	1	6

1 The kit for 24 x 96 preparations (REF 740665.24) consists of 6 x REF 740665.4.

2 For preparation of working solutions and storage conditions see section 3.

3 Elution Buffer BE: 5 mM Tris/HCl, pH 8.5

4 For use with vacuum only

5 Sets of 1 rack, 12 strips with 8 tubes each, including Cap Strips

Kit contents *continued*

NucleoSpin® 96 Blood Core Kit	
REF	4 x 96 preps 740456.4
Lysis Buffer BQ1	125 mL
Wash Buffer B5 (Concentrate) ¹	2 x 100 mL
Wash Buffer BW	300 mL
Elution Buffer BE ²	125 mL
Proteinase K (lyophilized) ¹	4 x 75 mg
Proteinase Buffer PB	15 mL
NucleoSpin® Blood Binding Plates (red rings)	4
User manual	1

1.2 Reagent to be supplied by user

- 96–100 % ethanol (for preparation of working solutions; see section 3)

For more detailed information regarding special hardware required for centrifuge or vacuum processing, please see section 2.3.

For recommended accessories for use of the flexible NucleoSpin® 96 Blood Core Kit (reduced kit composition; REF 740456.4), please see section 2.4.

¹ For preparation of working solutions and storage conditions see section 3.

² Elution Buffer BE: 5 mM Tris/HCl, pH 8.5

2 Product description

2.1 The basic principle

The **NucleoSpin® 96 Blood** kits are designed for the isolation of genomic DNA from whole blood, buffy coat, or cultured cells. Lysis is achieved by incubation of whole blood in a lysis buffer containing chaotropic ions in the presence of Proteinase K at room temperature. For optimal lysis, a microplate shaker is recommended. Appropriate conditions for binding of DNA to the silica membrane in the NucleoSpin® Blood Binding Plate are created by addition of ethanol to the lysate. The binding process is reversible and specific to nucleic acids. Contaminations are removed by three wash steps with ethanolic buffers. Pure genomic DNA is finally eluted under low ionic strength conditions in a slightly alkaline elution buffer.

2.2 Kit specifications

- **NucleoSpin® 96 Blood** kits are designed for the rapid, small-scale preparation of highly pure genomic DNA from whole animal or human blood, serum, plasma, or other body fluids. The obtained DNA can be used directly as template for PCR, blotting, or any kind of enzymatic reactions.
- The kits provide reagents and consumables for the purification of up to 20 µg (average 4–6 µg) of pure genomic DNA from 200 µL whole blood with an A_{260}/A_{280} ratio between 1.8 and 1.9 and a typical concentration of 20–60 ng/µL.
- Fresh and frozen blood and blood treated either with EDTA, citrate, or heparin can be used. The procedure is optimized for a sample volume of 200 µL. Using the **NucleoSpin® 96 Blood** kits allows simultaneous processing of up to 96 samples typically within less than 70 minutes.
- **NucleoSpin® 96 Blood** kits can be processed completely at room temperature.
- **NucleoSpin® 96 Blood** can be processed by vacuum or centrifugation. The kits allow for easy automation on common liquid handling instruments. For more information about the automation process and the availability of ready-to-run scripts for certain platforms, please refer to section 2.5 and contact your local distributor or MN directly.
- The **NucleoSpin® 96 Blood** kits allow for the purification of multiples of 96 samples. The kits are supplied with accessory plates for highest convenience. **The NucleoSpin® 96 Blood Core Kit** provides the buffers, Proteinase K and NucleoSpin® Blood Binding Plates only. Accessory components (e.g., lysis plates, elution plates) are not provided with the core kit but can be individually selected from a variety of suitable accessories (see section 6.2 for further information). This allows highest flexibility for the user.

Table 1: Kit specifications at a glance

Parameters	NucleoSpin® 96 Blood (Core)
Technology	Silica-membrane technology
Format	96-well plates
Processing	Manual or automated, optimized for vacuum processing
Sample material	Whole blood treated with EDTA, citrate, heparin, CPDA, human or animal blood Up to 200 µL whole blood, 2x 10 ⁶ cultured cells
Fragment size	300 bp–approx. 50 kbp
Typical yield	4–6 µg
A ₂₆₀ /A ₂₈₀	1.8–1.9
Elution volume	100 µL
Preparation time	70 min/plate
Binding capacity	20 µg

2.3 Required hardware

Vacuum processing

The **NucleoSpin® 96 Blood** kit can be used with the NucleoVac 96 Vacuum Manifold (see ordering information). When using **NucleoSpin® 96 Blood** with less than 96 samples, Self-adhering PE Foil (see ordering information) should be used in order to close and protect non-used wells of the NucleoSpin® Blood Binding Plate and thus guarantee proper vacuum.

Establish a reliable vacuum source for the NucleoVac 96 Vacuum Manifold. The manifold may be used with a vacuum pump, house vacuum, or water aspirator. We recommend a vacuum of -0.2 to -0.4 bar (reduction of atmospheric pressure). The use of the NucleoVac Vacuum Regulator (see ordering information) is recommended. Alternatively, adjust the vacuum so that during the purification the sample flows through the column with a rate of 1–2 drops per second. Depending on the amount of sample being used, the vacuum times may need to be increased for complete filtration.

Centrifugation

For centrifugation, a microtiterplate centrifuge is required. This centrifuge must be able to accommodate the NucleoSpin® Blood Binding Plate stacked on a Round- or Square-well Block and reach accelerations of 5,600–6,000 x *g* is required (bucket height: 85 mm).

Regarding waste collection, suitable consumables (e.g., MN Square-well Blocks) are necessary and they are not included in the kit. For the most convenient handling, without the need of emptying and reusing the MN Square-well Blocks, we recommend using six MN





Square-well Blocks if two 96-well plates are processed at once (see ordering information). Alternatively, it is possible to empty the MN Square-well Blocks after every centrifugation step, reducing the amount of MN Square-well Blocks needed.



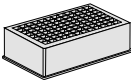
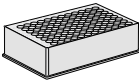

2.4 Recommended accessories for use of the NucleoSpin® 96 Blood Core Kit

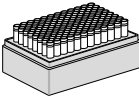
The **NucleoSpin® 96 Blood Core Kit** provides all necessary buffers, enzymes, and NucleoSpin® Binding Plates. Accessories (e.g., lysis plates, waste collection plates, elution plates, or tubes) are not provided with the core kit. The reduced kit composition along with a large variety of separately available accessories, allow optimal adjustment of the kit to individual user needs. The user can select additional consumables according to his requirements for highest flexibility.

For use of **NucleoSpin® 96 Blood Core Kit**, follow the standard protocols (see section 5.1 or 5.2, respectively).

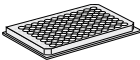
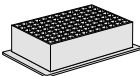
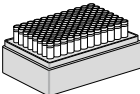
Recommended accessories for use of the **NucleoSpin® 96 Blood Core Kit** are available from MACHEREY-NAGEL. For ordering information please refer to section 6.2.

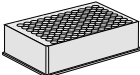
Protocol step	Suitable consumables, not supplied with the core kits	Remarks	
1. Lyse samples	4 x Lysis Block per 4 x 96 preps or 4 x Round-well Block with Cap Strips per 4 x 96 preps or 4 x Rack of Tube Strips with Cap Strips per 4 x 96 preps	    	Round-well Blocks and Tube Strips can be closed with Cap Strips.

Protocol step	Suitable consumables, not supplied with the core kits	Remarks
3. Transfer samples	4 x MN Wash Plate per 4 x 96 preps 	MN Wash Plate minimizes the risk of cross contamination (vacuum processing).
	2 x MN Square-well Block 	For waste collection during centrifugation (reusable).
8. Elute DNA	4 x Rack of Tubes Strips with Cap Strips per 4 x 96 preps 	Round-well Blocks and Tube Strips can be closed with Cap Strips.
	or 	
	4 x Round-well Block with Cap Strips per 4 x 96 preps  	

2.5 Automated processing on robotic platforms

NucleoSpin® 96 Blood can be fully automated on many common laboratory workstations. For the availability of scripts and general considerations about adapting **NucleoSpin® 96 Blood** on a certain workstation, please contact MN. Full processing under vacuum enables complete automation without the need for centrifugation steps for drying of the membrane or for elution.

The risk of cross-contamination is reduced by optimized vacuum settings during the elution step and by the improved shape of the outlets of the NucleoSpin® 96 Blood Binding Plate.

Drying of the NucleoSpin® Blood Binding Plate under vacuum is sufficient because the bottom of the plate is protected from spraying wash buffer during the washing steps by the MN Wash Plate. Thus, if possible, the MN Wash Plate should be integrated into the automated procedure. The MN Frame (see ordering information) can be used to position the MN Wash Plate inside the vacuum chamber. Thorough cleaning of the vacuum chamber is recommended after each run to prevent forming of gDNA-containing aerosols.

Visit MN online at www.mn-net.com or contact your local MACHEREY-NAGEL distributor for technical support regarding hardware, software, setup instructions, and selection of the protocol. Several application notes of the **NucleoSpin® 96 Blood** kit on various automation workstations can also be found at www.mn-net.com at Bioanalysis / Literature.

2.6 Elution procedure

Recovery of gDNA from the membrane depends on the elution volume. Elution volumes of 50–200 μL are possible, with an optimum of 100–125 μL dispensed volume. The purity is not effected by the elution volume. See the table below for correlation between dispensed elution buffer volume and typical recoveries following the standard protocol.

Recovery volumes in correlation to applied elution volumes

Dispensed elution volume	40 μL	60 μL	80 μL	100 μL	120 μL
Recovered volume:					
Vacuum	25 μL	45 μL	65 μL	85 μL	105 μL
Centrifuge	38 μL	58 μL	78 μL	98 μL	118 μL

If highest yield is required, preheating of the elution buffer to 70°C will give about 10–15% higher yields by supporting DNA recovery from the membrane.

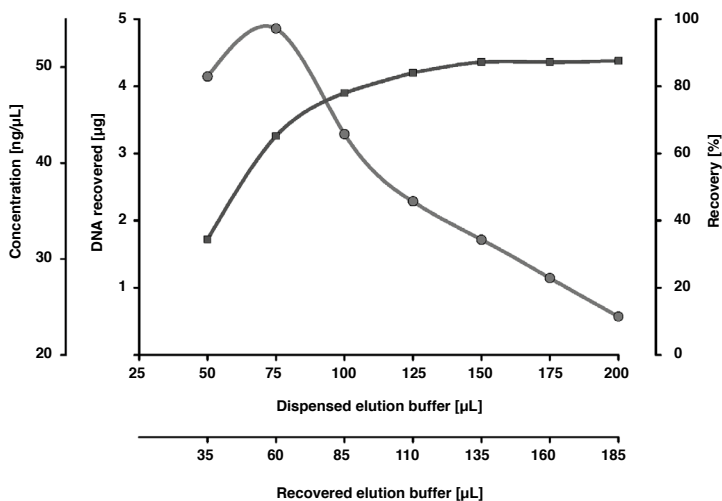

Figure 1 Elution of genomic DNA (vacuum processing)

Total DNA yield, recovery (- ■ -) and concentration of recovered DNA (- ● -) are plotted versus dispensed elution buffer volume. High elution buffer volumes result in high elution efficiency whereas high concentrated DNA solutions can be obtained with smaller elution buffer volumes. The dead volume of the silica membrane under vacuum is approximately 15 μL .

3 Storage conditions and preparation of working solutions

Attention: Buffers BQ1 and BW contain chaotropic salts! Wear gloves and goggles!

CAUTION: Buffers BQ1 and BW contain guanidine hydrochloride which can form highly reactive compounds when combined with bleach (sodium hypochlorite). DO NOT add bleach or acidic solutions directly to the sample-preparation waste.

Storage conditions:

- Store NucleoSpin® Blood Binding Plates at 4°C upon arrival.
- All other kit components should be stored at room temperature (18–25 °C) and are stable for at least one year. Storage at lower temperatures may cause precipitation of salts. If precipitation occurs, incubate the bottle for several minutes at about 30–40 °C and mix well until the precipitate is dissolved.

Before starting any **NucleoSpin® 96 Blood** protocol, prepare the following:

- **Wash Buffer B5:** Add the indicated volume of ethanol (96–100 %) to Buffer B5 Concentrate before use. Mark the label of the bottle to indicate that ethanol was added. Buffer B5 is stable at room temperature (18–25 °C) for at least one year.
- **Proteinase K:** Add the indicated volume of Proteinase Buffer PB to dissolve lyophilized **Proteinase K**. Proteinase K solution is stable at -20°C for at least 6 months.

	NucleoSpin® 96 Blood	NucleoSpin® 96 Blood	NucleoSpin® 96 Blood Core Kit
REF	1 x 96 preps 740665.1	4 x 96 preps 740665.4	4 x 96 preps 740456.4
Wash Buffer B5 (Concentrate)	100 mL Add 400 mL ethanol	4 x 100 mL Add 400 mL ethanol to each bottle	4 x 100 mL Add 400 mL ethanol to each bottle
Proteinase K (lyophilized)	75 mg Add 3.35 mL Proteinase Buffer	4 x 75 mg Add 3.35 mL Proteinase Buffer to each vial	4 x 75 mg Add 3.35 mL Proteinase Buffer to each vial



4 Safety instructions

The following components of the **NucleoSpin® 96 Blood** and **NucleoSpin® 96 Blood Core Kit** contain hazardous contents.

Wear gloves and goggles and follow the safety instructions given in this section.

GHS classification

Only harmful features do not need to be labeled with H and P phrases up to 125 mL or 125 g. *Mindergefährliche Eigenschaften müssen bis 125 mL oder 125 g nicht mit H- und P-Sätzen gekennzeichnet werden.*

Component	Hazard contents	GHS symbol	Hazard phrases	Precaution phrases
<i>Inhalt</i>	<i>Gefahrstoff</i>	<i>GHS-Symbol</i>	<i>H-Sätze</i>	<i>P-Sätze</i>
BQ1	Guanidinium thiocyanate 50–66 % <i>Guanidinthiocyanat 50–66 %</i> CAS 50-01-1	 WARNING ACHTUNG	302, 315, 319	264W, 280sh, 301+312, 330
BW	Guanidinium hydrochloride 36–50 % and 2-propanol 20–35 % <i>Guanidinhydrochlorid 36–50 % und 2-Propanol 20–35 %</i> CAS 50-01-1, 67-63-0	 WARNING ACHTUNG	226, 302, 319, 336	210, 260D, 264W, 280sh, 301+312, 330
Liquid Proteinase K	Proteinase K 90–100 % <i>Proteinase K 90–100 %</i> CAS 39450-01-6	 DANGER GEFAHR	315, 319, 334	261sh, 280sh, 342+311

Hazard phrases

H 226	Flammable liquid and vapor. <i>Flüssigkeit und Dampf entzündbar.</i>
H 302	Harmful if swallowed. <i>Gesundheitsschädlich bei Verschlucken.</i>
H 315	Causes skin irritation. <i>Verursacht Hautreizungen.</i>
H 319	Causes serious eye irritation. <i>Verursacht schwere Augenreizung.</i>
H 334	May cause allergy or asthma symptoms or breathing difficulties if inhaled. <i>Kann bei Einatmen Allergie, asthmaartige Symptome oder Atembeschwerden verursachen.</i>
H 336	May cause drowsiness or dizziness. <i>Kann Schläfrigkeit und Benommenheit verursachen.</i>

Precaution phrases

- P 210 Keep away from heat/sparks/open flames/hot surfaces. No smoking.
Von Hitze, heißen Oberflächen, Funken, offenen Flammen sowie anderen Zündquellenarten fernhalten. Nicht rauchen.
- P 260D Do not breathe vapors.
Dampf nicht einatmen.
- P 261sh Avoid breathing dust/vapors.
Einatmen von Staub/Dampf vermeiden.
- P 264W Wash with water thoroughly after handling.
Nach Gebrauch mit Wasser gründlich waschen.
- P 280sh Wear protective gloves/eye protection.
Schutzhandschuhe/Augenschutz tragen.
- P 301+312 IF SWALLOWED: Call a POISON CENTER/doctor if you feel unwell.
BEI VERSCHLUCKEN: Bei Unwohlsein GIFTINFORMATIONSZENTRUM/Arzt anrufen.
- P 330 Rinse mouth.
Mund ausspülen.
- P 342+311 If experiencing respiratory symptoms: Call a POISON CENTER/doctor.
Bei Symptomen der Atemwege: GIFTINFORMATIONSZENTRUM/Arzt anrufen.

For further information please see Material Safety Data Sheets (www.mn-net.com).
Weiterführende Informationen finden Sie in den Sicherheitsdatenblättern (www.mn-net.com).



The symbol shown on labels refers to further safety information in this section.
Das auf Etiketten dargestellte Symbol weist auf weitere Sicherheitsinformationen dieses Kapitels hin.

5 Protocols

5.1 NucleoSpin® 96 Blood – vacuum processing

- For hardware requirements, refer to section 2.3.
- For detailed information regarding the vacuum manifold setup, see page 16.
- For detailed information on each step, see page 16.
- For use of the NucleoSpin® 96 Blood Core Kit (REF 740456.4), refer to section 2.4 regarding recommended accessories.

Before starting the preparation:

- Check if Buffer B5 and Proteinase K were prepared according to section 3.
- Preheat Elution Buffer BE to 70 °C.

Protocol-at-a-glance

1	Lyse samples	200 µL blood (equilibrated to room temperature) 25 µL Proteinase K 200 µL BQ1 Mix 3 times Incubate at RT, 10 min or Mix 3 times and shake at 1250 rpm at RT, 10 min
2	Adjust DNA binding conditions	200 µL ethanol Mix at least 3–5 times <i>Note: High-speed pipetting (400 µL/s)</i> <i>should be used for optimized mixing.</i>
		Prepare the NucleoVac 96 Vacuum Manifold
3	Transfer lysates to NucleoSpin® Blood Binding Plate	
4	Overlay samples with Buffer B5	150 µL B5

5	Bind DNA to silica membrane of the NucleoSpin® Blood Binding Plate	- 0.2 bar*, 5 min
6	Wash silica membrane	600 µL BW -0.2 bar*, 3 min
		900 µL B5 -0.2 bar*, 1 min
		900 µL B5 -0.2 bar*, 1 min
Remove MN Wash Plate		
7	Dry silica membrane	- 0.6 bar*, 10 min
8	Elute DNA	50–200 µL BE Incubate 5 min at RT - 0.6 bar*, 1 min

* Reduction of atmospheric pressure

Setup of vacuum manifold:

Binding / Washing steps

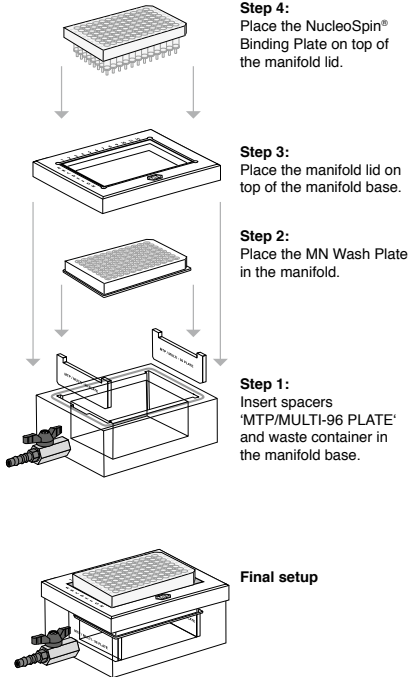

Elution step

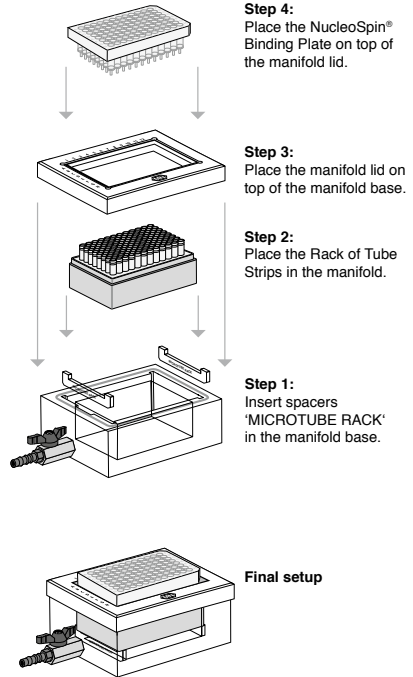

Detailed protocol

- For hardware requirements, refer to section 2.3.
- For detailed information regarding the vacuum manifold setup, see page 16.
- For use of the NucleoSpin® 96 Blood Core Kit (REF 740456.4), refer to section 2.4 regarding recommended accessories.

Before starting the preparation:

- Check if Buffer B5 and Proteinase K were prepared according to section 3.
 - *Preheat Elution Buffer BE to 70 °C (optional).*
-

1 Lyse samples

Dispense **25 µL Proteinase K** and **200 µL blood** (equilibrated to room temperature) to each well of the Lysis Block.

Add **200 µL Buffer BQ1** to each lysis well, **mix 3 times** by pipetting up and down and incubate samples at least **10 min at room temperature**.

or:

Add **200 µL Buffer BQ1** to each well. **Mix 3 times** by pipetting up and down and shake samples during incubation. Recommended are 10 min at **1250 rpm**. Shake at room temperature.

Prepare the NucleoVac 96 Vacuum Manifold:

Place waste tray into vacuum manifold base. Insert spacers labeled 'MTP/MULTI-96 PLATE' notched side up and place the MN Wash Plate on them. Close the manifold with the manifold lid.

Place the NucleoSpin® Blood Binding Plate on top of the manifold.

2 Adjust DNA binding conditions

Add **200 µL 96–100% ethanol** to each well of the Lysis Block. Again, take care not to moisten the rims of the individual wells while dispensing the buffer. **Mix** by pipetting up and down **at least 3–5 times**. Spin briefly (10 s; 1,500 x g) to collect any sample from the lid.

Note: High-speed pipetting (400 µL/s) should be used for optimal mixing, if possible.

3 Transfer lysates

Transfer the samples from the Lysis Block to the NucleoSpin® Blood Binding Plate.

Note: Do not moisten the rims of the individual wells while dispensing the samples, as this might lead to cross-contamination.

4 Overlay samples with Buffer B5

Overlay crude lysate on the NucleoSpin® Blood Binding Plate slowly (50 µL/s) with **150 µL Buffer B5**.

5 Bind DNA to silica membrane

Apply vacuum until all lysates have passed through the wells of the NucleoSpin® Blood Binding Plate (**-0.2 bar***; **5 min**). Release the vacuum.

6 Wash silica membrane

1st wash

Add **600 µL Buffer BW** to each well of the NucleoSpin® Blood Binding Plate. Apply vacuum (**-0.2 bar***; **3 min**) until all buffer has passed through the wells of the NucleoSpin® Blood Binding Plate. Release the vacuum.

2nd wash

Add **900 µL Buffer Buffer B5** to each well of the NucleoSpin® Blood Binding Plate. Apply vacuum (**-0.2 bar***; **1 min**) until all buffer has passed through the wells of the NucleoSpin® Blood Binding Plate. Release the vacuum.

3rd wash

Add **900 µL Buffer Buffer B5** to each well of the NucleoSpin® Blood Binding Plate. Apply vacuum (**-0.2 bar***; **1 min**) until all buffer has passed through the wells of the NucleoSpin® Blood Binding Plate. Release the vacuum.

Remove MN Wash Plate

After the final washing step, close the valve, release the vacuum, and remove the NucleoSpin® Blood Binding Plate from the vacuum manifold. Put it on a clean paper towel to remove residual EtOH-containing wash buffer. Remove manifold lid, MN Wash Plate, and waste container from the vacuum manifold.

7 Dry membrane

Remove any residual washing buffer from the outlets of the NucleoSpin® Blood Binding Plate. If necessary, tap the outlets onto a clean paper sheet (supplied with the MN Wash Plate) or soft tissue until no drops come out. Insert the NucleoSpin® Blood Binding Plate again into the lid and close the manifold. Apply maximum vacuum (**at least -0.6 bar***) for **10 min** to dry the membrane completely. This step is necessary to eliminate traces of ethanol.

Note: The ethanol in Buffer B5 inhibits enzymatic reactions and has to be removed completely before eluting DNA.

Finally, release the vacuum.

* Reduction of atmospheric pressure

8 Elute DNA

Insert spacers 'MICROTUBE RACK' into the NucleoVac 96 Vacuum Manifold's short sides. Place a Rack of Tube Strips onto the spacer. Close the vacuum manifold and place the NucleoSpin® Blood Binding Plate on top. Dispense **50–200 µL Buffer BE** directly to the bottom of each well. Incubate for 5 min at **room temperature**. Apply vacuum for elution (**-0.6 bar***; **1 min**). Release vacuum. For alternative elution procedures see section 2.3.

Finally, close Tube Strips with Cap Strips for storage.

Centrifuge the Rack of Tube Strips shortly to collect all sample at the bottom of the Tube Strips.

Optional: Preheat Buffer BE to 70°C to increase yield.

* Reduction of atmospheric pressure

5.2 NucleoSpin® 96 Blood – centrifuge processing

Although the **NucleoSpin® 96 Blood** kit is designed primarily for vacuum processing, centrifuge processing is also possible.

Follow the standard protocol as described in section 5.1. The vacuum steps are substituted by centrifugation of the NucleoSpin® Blood Binding Plate at 5,600–6,000 x *g* for 3 min.

Drying of the silica membrane is achieved by centrifugation for 10 min after the second Buffer B5 washing step. A separate drying step is not required.

During all centrifugation steps, the NucleoSpin® Blood Binding Plate should be placed on a MN Square-well Block (see ordering information) to collect the waste.

During the elution step the NucleoSpin® Blood Binding Plate is placed on top of a Rack of Tube Strips.

5.3 Modified lysis of blood samples

This modified lysis procedure may be used to increase the yield on some liquid handling instruments, for example, instruments with 4 channel pipetting system or if the recommended mixing speed of 400 µL/s for the addition of ethanol to adjust binding conditions can not be achieved.

-
- A** Pre-dispense **25 µL of Proteinase K** solution to each well of the Lysis Block.
-
- B** Transfer **200 µL blood** (equilibrated to room temperature) to the Lysis Block. Do not moisten the rims of the well.
-
- C** Add **75 µL Buffer BQ1** to each sample, pipette up and down **3 times** and mix by shaking (**15 min**) at room temperature.
- Alternatively, pipette up and down **10 times** and incubate **15 min** at room temperature.
-
- D** Add **400 µL Buffer BQ1 / ethanol-mix** (1:1, v/v) to each well of the Lysis Block, mix at least 2 times and transfer lysate (total volume 700 µL) to the NucleoSpin® Blood Binding Plate.
-
- E** Overlay crude lysate on the NucleoSpin® Blood Binding Plate slowly (~ 50 µL/s) with **150 µL Buffer B5**. Wait for **1 min** before applying vacuum for binding.
-
- Proceed with step 5 (Bind DNA) of the standard procedure (see section 5.1).
-

5.4 Cultured animal or human cells

Before starting the preparation:

- Check if Wash Buffer B5 and Proteinase K were prepared according to section 3.
- Seal unused wells of NucleoSpin® Blood Binding Plate with Self-adhering PE-Foil (see ordering information).

A Harvest cells

Harvest cells (maximum starting amount 2×10^6) and pellet them in the lysis vessel by centrifugation (**300 x g, 4 min**). Remove supernatant and resuspend cell pellets in **200 µL PBS**.

B Lyse cells

Add **25 µL Proteinase K** and **200 µL Buffer BQ1** to each well and shake lysis vessel at least 10 min at room temperature. Complete lysis is important for optimal yields.

Optional: Add 10 µL **RNase** (25 mg/mL, not supplied with the kit, see ordering information) to each well after incubation if genomic DNA has to be free of RNA.

Proceed with step 2 (Adjust binding conditions) of the standard procedure (section 5.1).

6 Appendix

6.1 Troubleshooting

Problem	Possible cause and suggestions
Poor DNA quality or yield	<i>Low concentration of leukocytes in the whole blood sample</i>
	<ul style="list-style-type: none"> • Prepare buffy coat from the blood sample.
	<i>Incomplete cell lysis</i>
	<ul style="list-style-type: none"> • Sample has not thoroughly been mixed with Buffer BQ1/Proteinase K. Use of a shaker is recommended for optimal results.
	<ul style="list-style-type: none"> • Proteinase K digestion was not optimal. Do not add Proteinase K directly to Buffer BQ1.
	<ul style="list-style-type: none"> • Increase incubation time. Incubate for at least 10 min at RT.
<i>Reagents not applied or restored properly</i>	<ul style="list-style-type: none"> • Reagents were not properly restored. Add the indicated volume of Proteinase Buffer PB to the Proteinase K vial and 96–100 % ethanol to Buffer B5 Concentrate and mix.
<i>Kit storage</i>	<ul style="list-style-type: none"> • Store aliquots of the reconstituted Proteinase K at -20 °C. • Store other kit components at room temperature. Storage at low temperatures may cause salt precipitation. • Keep bottles tightly closed in order to prevent evaporation or contamination.
<i>Suboptimal elution</i>	<p>Elution efficiencies decrease dramatically if elution is done with buffers with pH < 7.0. Use slightly alkaline elution buffer like Buffer BE (pH 8.5).</p> <p>Be sure that all of the elution buffer gets into contact with the silica membrane. No drops should stick to the walls of the columns.</p>

Problem	Possible cause and suggestions
Clogging of NucleoSpin® Blood Binding Strip	<p><i>Clogging of the NucleoSpin® Blood Binding Plate</i></p> <ul data-bbox="309 252 969 427" style="list-style-type: none"> • If blood samples are too old and clotting occurs, clogging of the NucleoSpin® Blood Binding Plate may appear. Check for blockage of NucleoSpin® Blood Binding Plate visually or automatically and remove supernatant. Increase time and strength for vacuum processing. Whole blood can be stored for several weeks at 4 °C. Freeze samples at -20 °C if blood should be stored for a longer periods.
	<p><i>Insufficient vacuum pressure</i></p> <ul data-bbox="309 491 969 600" style="list-style-type: none"> • Check if the vacuum manifold lid fits tightly on the manifold base if vacuum is turned on. • Make sure that pump works properly and that any in-line filters are not blocked.
Contamination of genomic DNA with RNA	<p><i>RNA carry-over</i></p> <ul data-bbox="309 671 969 715" style="list-style-type: none"> • Add 10 µL (25 mg/mL) RNase A to the sample after the incubation of step 2, as recommended for working with fresh, unfrozen cells.
	<p><i>Carry-over of ethanol</i></p> <ul data-bbox="309 783 969 919" style="list-style-type: none"> • Be sure to remove all traces of Buffer B5 after the final washing step. Dry the NucleoSpin® Blood Binding Plate for at least 10 min with maximum vacuum. • Following the final wash step, place NucleoSpin® Blood Binding Plate in an incubator for 10 min at 70 °C to evaporate ethanol.
Cross-contamination	<p><i>Splattering of eluate</i></p> <ul data-bbox="309 986 969 1054" style="list-style-type: none"> • If eluting with vacuum, be sure that the distance between the outlets of the NucleoSpin® Blood Binding Plate and the Tube Strips is minimized.
	<p><i>Sample transfer</i></p> <ul data-bbox="309 1123 969 1145" style="list-style-type: none"> • Be sure that no liquid drops out of the tips while moving the tips.

6.2 Ordering information

Product	REF	Pack of
NucleoSpin® 96 Blood	740665.1	1 x 96 preps
	740665.4	4 x 96 preps
	740665.24	24 x 96 preps
NucleoSpin® 96 Blood Core Kit	740456.4	4 x 96 preps
NucleoSpin® 8 Blood	740664	12 x 8 preps
	740664.5	60 x 8 preps
NucleoSpin® 8 Blood Core Kit	740455.4	48 x 8 preps
Buffer BQ1	740923	125 mL
Buffer B5 Concentrate (for 500 mL Buffer B5)	740921.100	100 mL
Buffer BW	740922.500	500 mL
Proteinase K	740506	100 mg
RNase A (lyophilized)	740505	100 mg
Lysis Block	740484	4
MN Square-well Block	740476	4
	740476.24	24
Rack of Tube Strips (1 set consists of 1 rack, 12 strips with 8 tubes each, and 12 Cap Strips)	740477	4 sets
	740477.24	24 sets
Round-well Block (1 set consists of 1 Round-well Block and 12 Cap Strips)	740475	4 sets
	740475.24	24 sets
MN Wash Plate	740479	4
	740479.24	24
Cap Strips	740478	48
	740478.24	288
MN Frame	740680	1
NucleoVac 96 Vacuum Manifold	740681	1
NucleoVac Vacuum Regulator	740641	1
Self-adhering PE Foil	740676	50

6.3 Product use restriction / warranty

NucleoSpin® 96 Blood (Core Kit) components are intended, developed, designed, and sold FOR RESEARCH PURPOSES ONLY, except, however, any other function of the product being expressly described in original MACHEREY-NAGEL product leaflets.

MACHEREY-NAGEL products are intended for GENERAL LABORATORY USE ONLY! MACHEREY-NAGEL products are suited for QUALIFIED PERSONNEL ONLY! MACHEREY-NAGEL products shall in any event only be used wearing adequate PROTECTIVE CLOTHING. For detailed information please refer to the respective Material Safety Data Sheet of the product! MACHEREY-NAGEL products shall exclusively be used in an ADEQUATE TEST ENVIRONMENT. MACHEREY-NAGEL does not assume any responsibility for damages due to improper application of our products in other fields of application. Application on the human body is STRICTLY FORBIDDEN. The respective user is liable for any and all damages resulting from such application.

DNA/RNA/PROTEIN purification products of MACHEREY-NAGEL are suitable for *IN-VITRO*-USES ONLY!

ONLY MACHEREY-NAGEL products specially labeled as IVD are also suitable for IN-VITRO-diagnostic use. Please pay attention to the package of the product. IN-VITRO-diagnostic products are expressly marked as IVD on the packaging.

IF THERE IS NO IVD SIGN, THE PRODUCT SHALL NOT BE SUITABLE FOR *IN-VITRO*-DIAGNOSTIC USE!

ALL OTHER PRODUCTS NOT LABELED AS IVD ARE NOT SUITED FOR ANY CLINICAL USE (INCLUDING, BUT NOT LIMITED TO DIAGNOSTIC, THERAPEUTIC AND/OR PROGNOSTIC USE).

No claim or representations is intended for its use to identify any specific organism or for clinical use (included, but not limited to diagnostic, prognostic, therapeutic, or blood banking). It is rather in the responsibility of the user or - in any case of resale of the products - in the responsibility of the reseller to inspect and assure the use of the DNA/RNA/protein purification products of MACHEREY-NAGEL for a well-defined and specific application.

MACHEREY-NAGEL shall only be responsible for the product specifications and the performance range of MN products according to the specifications of in-house quality control, product documentation and marketing material.

This MACHEREY-NAGEL product is shipped with documentation stating specifications and other technical information. MACHEREY-NAGEL warrants to meet the stated specifications. MACHEREY-NAGEL's sole obligation and the customer's sole remedy is limited to replacement of products free of charge in the event products fail to perform as warranted. Supplementary reference is made to the general business terms and conditions of MACHEREY-NAGEL, which are printed on the price list. Please contact us if you wish to get an extra copy.

There is no warranty for and MACHEREY-NAGEL is not liable for damages or defects arising in shipping and handling (transport insurance for customers excluded), or out of accident or improper or abnormal use of this product; defects in products or components not manufactured by MACHEREY-NAGEL, or damages resulting from such non-MACHEREY-NAGEL components or products.

MACHEREY-NAGEL makes no other warranty of any kind whatsoever, and SPECIFICALLY DISCLAIMS AND EXCLUDES ALL OTHER WARRANTIES OF ANY KIND OR NATURE

WHATSOEVER, DIRECTLY OR INDIRECTLY, EXPRESS OR IMPLIED, INCLUDING, WITHOUT LIMITATION, AS TO THE SUITABILITY, REPRODUCTIVITY, DURABILITY, FITNESS FOR A PARTICULAR PURPOSE OR USE, MERCHANTABILITY, CONDITION, OR ANY OTHER MATTER WITH RESPECT TO MACHEREY-NAGEL PRODUCTS.

In no event shall MACHEREY-NAGEL be liable for claims for any other damages, whether direct, indirect, incidental, compensatory, foreseeable, consequential, or special (including but not limited to loss of use, revenue or profit), whether based upon warranty, contract, tort (including negligence) or strict liability arising in connection with the sale or the failure of MACHEREY-NAGEL products to perform in accordance with the stated specifications. This warranty is exclusive and MACHEREY-NAGEL makes no other warranty expressed or implied.

The warranty provided herein and the data, specifications and descriptions of this MACHEREY-NAGEL product appearing in MACHEREY-NAGEL published catalogues and product literature are MACHEREY-NAGEL's sole representations concerning the product and warranty. No other statements or representations, written or oral, by MACHEREY-NAGEL's employees, agent or representatives, except written statements signed by a duly authorized officer of MACHEREY-NAGEL are authorized; they should not be relied upon by the customer and are not a part of the contract of sale or of this warranty.

Product claims are subject to change. Therefore please contact our Technical Service Team for the most up-to-date information on MACHEREY-NAGEL products. You may also contact your local distributor for general scientific information. Applications mentioned in MACHEREY-NAGEL literature are provided for informational purposes only. MACHEREY-NAGEL does not warrant that all applications have been tested in MACHEREY-NAGEL laboratories using MACHEREY-NAGEL products. MACHEREY-NAGEL does not warrant the correctness of any of those applications.

Last updated: 07 / 2010, Rev. 03

Please contact:

MACHEREY-NAGEL GmbH & Co. KG

Tel.: +49 (0) 24 21 969 270

e-mail: tech-bio@mn-net.com

Trademarks:

BioRobot® is a registered trademark of the Qiagen GmbH Corporation

NucleoSpin® is a registered trademark of MACHEREY-NAGEL GmbH & Co KG

All used names and denotations can be brands, trademarks, or registered labels of their respective owner – also if they are not special denotation. To mention products and brands is only a kind of information (i.e., it does not offend against trademarks and brands and can not be seen as a kind of recommendation or assessment). Regarding these products or services we can not grant any guarantees regarding selection, efficiency, or operation.

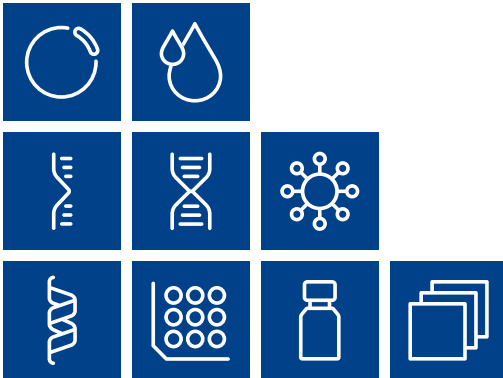

www.mn-net.com

MACHEREY-NAGEL



MACHEREY-NAGEL GmbH & Co. KG
Neumann-Neander-Str. 6-8
52355 Düren · Germany

DE Tel.: +49 24 21 969-0
CH Tel.: +41 62 388 55 00
FR Tel.: +33 388 68 22 68
US Tel.: +1 484 821 0984

info@mn-net.com
sales-ch@mn-net.com
sales-fr@mn-net.com
sales-us@mn-net.com

A028836/0210.4